

Modell	Nennb.dauer	Batterie	Lumen	Lampe bei Notbeleuchtung	€
Notstromleuchten:					
Argos-M N1	1 h	Ni-Cd	55	FL 8 W	-----
Argos-M N2	1 h	Ni-Cd	75	FL 8 W	-----
Argos-M N3	1 h	Ni-Cd	120	FL 8 W	-----
Argos-M N5	1 h	Ni-Cd	175	FL 8 W	-----
Argos-M N6	1 h	Ni-Cd	260	FL 8 W	-----
Argos-M N8	1 h	Ni-Cd	350	FL 8 W	-----
Argos-M N11	1 h	Ni-Cd	460	PL 11 W	-----
Argos-M 2N3	2 h	Ni-Cd	80	FL 8 W	-----
Argos-M 2N7	2 h	Ni-Cd	205	FL 8 W	-----
Argos-M 3N4	3 h	Ni-Cd	170	FL 8 W	-----
Argos-M LD N2	1 h	Ni-Cd	90	ILMLED	-----
Argos-M LD N3	1 h	Ni-Cd	130	ILMLED	-----
Argos-M LD N5	1 h	Ni-Cd	220	ILMLED	-----
Argos-M LD N6	1 h	Ni-Cd	290	ILMLED	-----
Argos-M LD N8	1 h	Ni-Cd	390	ILMLED	-----
Argos-M LD 2N5	2 h	Ni-Cd	210	ILMLED	-----
Argos-M LD 3N4	3 h	Ni-Cd	150	ILMLED	-----

Modell	Nennb.dauer	Batterie	Lumen	Lampe b. Notbel./Netz	€
Dauerleuchten:					
Notbel./Bel.					
Argos-M LD P3	1 h	Ni-Mh	90	LGPLED	-----
Argos-M LD P6	1 h	Ni-Mh	240	LGPLED	-----
Argos-M LD 2P3	2 h	Ni-Mh	90	LGPLED	-----
Argos-M LD 2P6	2 h	Ni-Mh	240	LGPLED	-----
Argos-M LD 3P3	3 h	Ni-Mh	90	LGPLED	-----
Argos-M LD 3P4	3 h	Ni-Mh	180	LGPLED	-----

Modell	Nennb.dauer	Batterie	Lumen	Lampe b. Notbel./Netz	€
Kombi-Leuchten: (1)					
Notbel. Bel.					
Argos-M C3	1 h	Ni-Cd	115 267	2 x FL 8 W	-----
Argos-M C6	1 h	Ni-Cd	245 267	2 x FL 8 W	-----
Argos-M C8	1 h	Ni-Cd	340 267	2 x FL 8 W	-----
Argos-M 2C5	2 h	Ni-Cd	205 267	2 x FL 8 W	-----
Argos-M 3C4	3 h	Ni-Cd	160 267	2 x FL 8 W	-----

Argos Eingebaut A Spezifisch für Selbsttest

Argos Eingebaut TCA Spezifisch für Selbsttest und DaisaTest-System

Enthält Mikroprozessor für Betrieb im Selbsttestmodus A oder Zentrale Steuerung DaisaTest TCA.

Referenz je nach gewähltem Modell mit A oder TCA ergänzen.

Bestellbeispiel: Argos-M N2 A/Argos-M N2 TCA

Modell	Nennb.dauer	Batterie	Lumen	Lampe bei Notbeleuchtung	A €	TCA €
Notstromleuchten:						
Argos-M N2	1 h	Ni-Cd	70	FL 8 W	-----	-----
Argos-M N3	1 h	Ni-Cd	130	FL 8 W	-----	-----
Argos-M N5	1 h	Ni-Cd	165	FL 8 W	-----	-----
Argos-M N6	1 h	Ni-Cd	255	FL 8 W	-----	-----
Argos-M N8	1 h	Ni-Cd	325	FL 8 W	-----	-----
Argos-M N10	1 h	Ni-Cd	390	PL 11 W	-----	-----
Argos-M 2N3	2 h	Ni-Cd	110	FL 8 W	-----	-----
Argos-M 2N5	2 h	Ni-Cd	165	FL 8 W	-----	-----
Argos-M 3N3	3 h	Ni-Cd	130	FL 8 W	-----	-----
Argos-M LD N2	1 h	Ni-Mh	90	ILMLED	-----	-----
Argos-M LD N3	1 h	Ni-Mh	140	ILMLED	-----	-----
Argos-M LD N5	1 h	Ni-Mh	190	ILMLED	-----	-----
Argos-M LD N6	1 h	Ni-Mh	280	ILMLED	-----	-----
Argos-M LD N8	1 h	Ni-Mh	390	ILMLED	-----	-----
Argos-M LD 2N5	2 h	Ni-Mh	220	ILMLED	-----	-----
Argos-M LD 3N4	3 h	Ni-Mh	180	ILMLED	-----	-----

Modell	Nennb.dauer	Batterie	Lumen	Lampe b. Notbel./Netz	A €	TCA €
Dauerleuchten:						
Notbel./Bel.						
Argos-M LD P3	1 h	Ni-Mh	90	LGPLED	-----	-----
Argos-M LD P6	1 h	Ni-Mh	240	LGPLED	-----	-----
Argos-M LD 2P3	2 h	Ni-Mh	90	LGPLED	-----	-----
Argos-M LD 2P6	2 h	Ni-Mh	240	LGPLED	-----	-----
Argos-M LD 3P3	3 h	Ni-Mh	90	LGPLED	-----	-----
Argos-M LD 3P4	3 h	Ni-Mh	180	LGPLED	-----	-----

Testzentrale TEV für Argos Eingebaut TCA: siehe Seite 128.

Argos Eingebaut Leuchte

Modell	Versorgungsspannung	Lumen	Lampe	€
Argos-M L8	220-230V 50/60Hz, 210-300V DC	267	FL 8 W	-----
Argos-M L11	220-230V 50/60Hz, 210-300V DC	429	PL 11 W	-----
Argos-M LD L3	220-230V 50/60Hz, 170-320V DC	90	ILMLED	-----
Argos-M LD L8	220-230V 50/60Hz, 170-320V DC	300	ILMLED	-----

Funktionsweise, gemeinsame Daten und Anmerkungen:

Die Notleuchten sind mit NiMH-Akkus ausgestattet und beinhalten eine mikroprozessorgesteuerte Impulsadeschaltung, durch die eine bedeutende Reduktion des Energieverbrauchs möglich ist.

(1) Geräte nicht für den Einbau in die Decke oder in die Wand geeignet, wenn keine Garantie für interne Lufterneuerung besteht.

Gefertigt nach der Norm EN 60598-2-22 (IEC 60598-2-22). Schutzgrad: IP44 IK04.

Ausführungen ■ Zubehör

■ Ausführungen

RABATTHÖHE 2

Ausführung	Beschreibung	Kennzeichnung	Aufpreis €
Farbe	Weiß (serienmäßig)	----	----
	Metallicgrau.	(GR)	----
	Silbergrau.	(RAL9006)	----
Versorgungsspannung: Unabhängig (FL und LED)	220-230V 50/60Hz	----	----
	110-127V 50/60Hz	(110-127V)	----
Leuchten (LED)	220-230V 50/60Hz, 170-320V DC	----	----
	24V 50/60Hz, 18-30V DC	(24V)	----



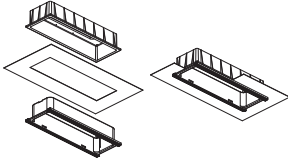
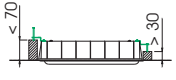
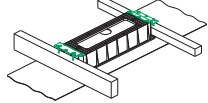





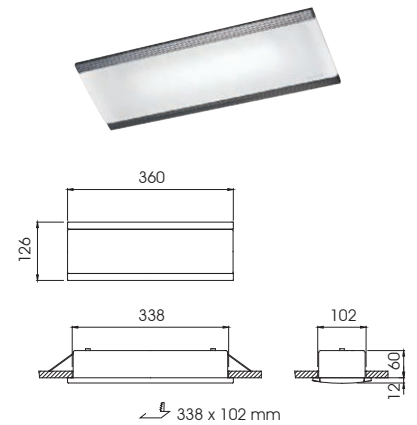









■ Zubehör

Schema	Referenz	Beschreibung	Sich ergebender Lichtstrom	€
	KTDM Argos	Satz für die Montage der Serie Argos eingebaut in Decken aus Metall.	----	----
 	KTLE Argos	Satz zur Ergänzung von KTDM Argos, um die Leuchte an den Profilen zu stützen.	----	----

Argos Eingebaut

Argos-M (GR)



Ref.	Beschreibung	S. ergeb. Lichtstrom	€																																				
RT...	<p>Notschilder. (Selbstklebend)</p> <p>RT: 290x90 mm.</p> <p>RTD: 180x90 mm, RTD1431: 90x90 mm.</p> <p>Erfüllt die Normen EN 1838 und EN ISO 7010.</p> <p>Lieferung von Schildern und Piktogrammen nach Maß gemäß Bestellung möglich.</p> <table border="1"> <thead> <tr> <th>Beschreibung</th> <th>Kennz.</th> <th>Beschreibung</th> <th>Kennz.</th> <th>Beschreibung</th> <th>Kennz.</th> </tr> </thead> <tbody> <tr> <td></td> <td>(RT1404)</td> <td></td> <td>(RT1421)</td> <td></td> <td>(RTD1428)</td> </tr> <tr> <td></td> <td>(RT1407)</td> <td></td> <td>(RT1422)</td> <td></td> <td>(RTD1429)</td> </tr> <tr> <td></td> <td>(RT1408)</td> <td></td> <td>(RT1423)</td> <td></td> <td>(RTD1430)</td> </tr> <tr> <td></td> <td>(RT1415)</td> <td></td> <td>(RT1426)</td> <td></td> <td>(RTD1431)</td> </tr> <tr> <td></td> <td>(RT1416)</td> <td></td> <td></td> <td></td> <td></td> </tr> </tbody> </table>	Beschreibung	Kennz.	Beschreibung	Kennz.	Beschreibung	Kennz.		(RT1404)		(RT1421)		(RTD1428)		(RT1407)		(RT1422)		(RTD1429)		(RT1408)		(RT1423)		(RTD1430)		(RT1415)		(RT1426)		(RTD1431)		(RT1416)					75%	----
Beschreibung	Kennz.	Beschreibung	Kennz.	Beschreibung	Kennz.																																		
	(RT1404)		(RT1421)		(RTD1428)																																		
	(RT1407)		(RT1422)		(RTD1429)																																		
	(RT1408)		(RT1423)		(RTD1430)																																		
	(RT1415)		(RT1426)		(RTD1431)																																		
	(RT1416)																																						